

LV Series

The Non-contact Method
Opens up the World of
Vibration Measurement

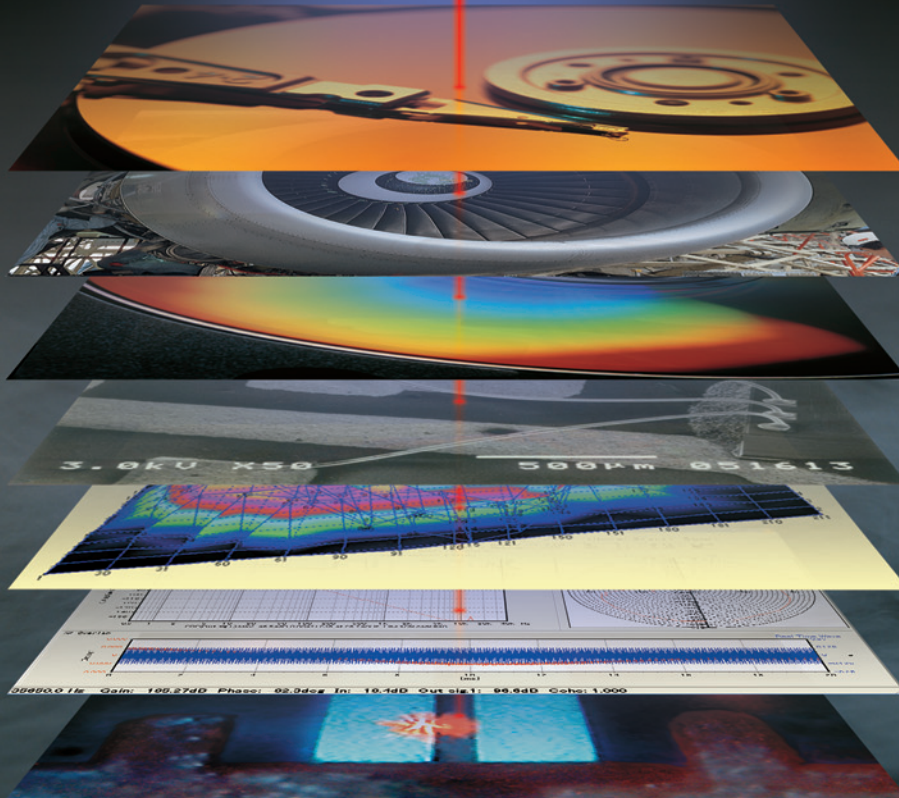

A New Discovery with Each Use Non-contact Measurement Makes it Possible

LV-1700 series

Transparent Rotational objects High temperature High frequency Ultra-small structures Through glass ...

Greatly increased detection ability

The new optics system used provides enhanced operability with sensitivity increased by 20 dB (compared to earlier models), and remarkably improved ease of use.

Small size, lightweight sensor

The small-format, lightweight sensor weighs approximately 650 g*, including the lens, and can be freely mounted on a wide variety of devices.

*excluding the cable

Safe Class 2 Laser Beam

The laser is a Class 2 visible red laser beam (approx. 633nm) with an output of only 1 mW or less. There are almost no restrictions with regard to operation or installation.

Short positioning distance of only 100 mm*

The new-design lens enables it to be positioned up to only 100 mm away from the measurement object. The 100-mm distance is a standard feature. Moreover, as the distance scale is marked on the lens, the sensor settings are easy to make.



* from the lens tip



*The LV-0712 displacement output board is mounted in the unit shown in the above photograph.

Covers a broad range, from general mechanical vibrations to high-frequency, large-amplitude vibrations

LV-1710

Wide-range, all-round model

Measurement frequency 1 Hz to 3 MHz, 0.3 μm/s to 10 m/s

- General mechanical vibrations
- High-speed mechanical vibrations in internal-combustion engines
- Ultrasonic tool, etc.

Easily handles a wide spectrum of vibrations, from ultra-minute vibrations to general mechanical vibrations

LV-1720

High-resolution, nano-range model

Measurement frequency 1 Hz to 300 kHz, 0.1 μm/s to 0.5 m/s

- Thin film vibrations
- Micromachine, microstructure vibrations
- General mechanical vibrations, etc.



*The LV-0722 displacement output board is mounted in the unit shown in the above photograph.

Essential information is displayed on the sensor.

Even when the sensor and the converter are at some distance from each other, the level meter and detection error display provided on the sensor enable quick confirmation of the detection status and easy setup.



CCD camera for magnified monitoring of the measurement object

The easily installable optional video monitor unit (LV-0147) enables magnification up to 35 times* to enable confirmation of the laser beam position on the same axis, and ensure precision measurement of small components.

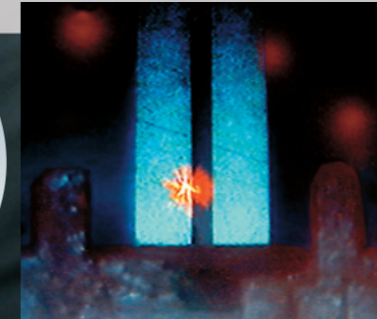

*14" monitor magnification

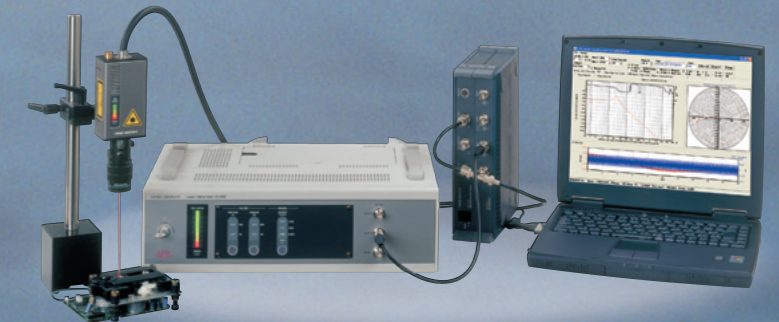

Using the DS-2000 and the DS-0242 servo analysis software together with the LV-1700 Series enables optical pickup actuator analysis.

Wide range of options

There is a wide range of peripheral devices available for the LV-1700 Series, from a fringe count displacement meter unit and a 20 MHz wideband unit through to a 90-degree reflecting mirror that bends laser light in small areas, to meet various application needs.

On-line control

An RS-232C interface is provided to enable on-line control.

All-in-one ultra-compact unit

The sensor fits right into the small-format converter unit for easy transportation and storage. The lightweight, all-in-one unit weighs only 12 kg, and can be easily carried around.



Storage trunk LV-0300

Option Boards for Displacement Output and Acceleration Output

If an option board is built into the LV-1710/1720, output of displacement or acceleration signals via the option connector is enabled.

Output impedance: 50 Ω
Voltage output: ±10 V

For LV-1710

LV-0712 Displacement output board

LV-1710 measurement ranges	Displacement measurement ranges		
	(1Hz to 20kHz)	(10Hz to 50kHz)	(1kHz to 200kHz)
1.0 (m/s) /V	100 (mm/V)	1 (mm/V)	10 (μm/V)
0.1 (m/s) /V	10 (mm/V)	100 (μm/V)	1 (μm/V)
0.01 (m/s) /V	1 (mm/V)	10 (μm/V)	100 (nm/V)

LV-0711 Acceleration output board

LV-1710 measurement ranges	Acceleration measurement ranges		
	(1Hz to 2kHz)	(1Hz to 20kHz)	(100Hz to 400kHz)
1.0 (m/s) /V	10 ³ (m/s ²) /V	10 ⁵ (m/s ²) /V	10 ⁷ (m/s ²) /V
0.1 (m/s) /V	10 ² (m/s ²) /V	10 ⁴ (m/s ²) /V	10 ⁶ (m/s ²) /V
0.01 (m/s) /V	10 ¹ (m/s ²) /V	10 ³ (m/s ²) /V	10 ⁵ (m/s ²) /V

For LV-1720

LV-0722 Displacement output board

LV-1720 measurement ranges	Displacement measurement ranges		
	(1Hz to 20kHz)	(10Hz to 50kHz)	(1kHz to 200kHz)
0.05 (m/s) /V	5 (mm/V)	50 (μm/V)	500 (nm/V)
0.01 (m/s) /V	1 (mm/V)	10 (μm/V)	100 (nm/V)
0.002 (m/s) /V	0.2 (mm/V)	2 (μm/V)	20 (nm/V)

LV-0721 Acceleration output board

LV-1720 measurement ranges	Acceleration measurement ranges		
	(1Hz to 2kHz)	(1Hz to 20kHz)	(100Hz to 300kHz)
0.05 (m/s) /V	5 x 10 ¹ (m/s ²) /V	5 x 10 ³ (m/s ²) /V	5 x 10 ⁵ (m/s ²) /V
0.01 (m/s) /V	10 ¹ (m/s ²) /V	10 ³ (m/s ²) /V	10 ⁵ (m/s ²) /V
0.002 (m/s) /V	2 (m/s ²) /V	2 x 10 ² (m/s ²) /V	2 x 10 ⁴ (m/s ²) /V

Both displacement output board (LV-0712/LV-0722) and acceleration output board (LV-0711/LV-0721) can not be built in (LV-1710/LV-1720) simultaneously.

LV-0120 Fringe Count Displacement Meter Unit



Applications

- Measurement of minute displacements and deformations in components and structures.
- Measurement of low-frequency vibrations.

Designed for use with the LV Series Laser Doppler Vibrometers, the LV-0120 is a displacement meter that uses the fringe count method. DC displacement measurement is also possible.

Maximum resolution: 5 nm

Output signal resolution: 13-bit

Measurement frequency range: DC to 100 kHz

Output signal: Analog signal ±10 V

Power supply: 100 VAC ±10% 1A (120/220/240 VAC on request.)

Operating temperature range: 0 to 40°C

Outer dimensions: 420 (W) x 100 (H) x 500 (D) mm

Weight: 6.5 kg

Range	Measurement range	Output voltage sensitivity	Maximum response speed
1	±20μm	±2μm/V	0.079m/s
2	±160μm	±16μm/V	0.74m/s
3	±1.25mm	±125μm/V	1m/s
4	±10mm	±1mm/V	10m/s
5	±80mm	±8mm/V	10m/s

LV-0160 20 MHz Wideband Unit

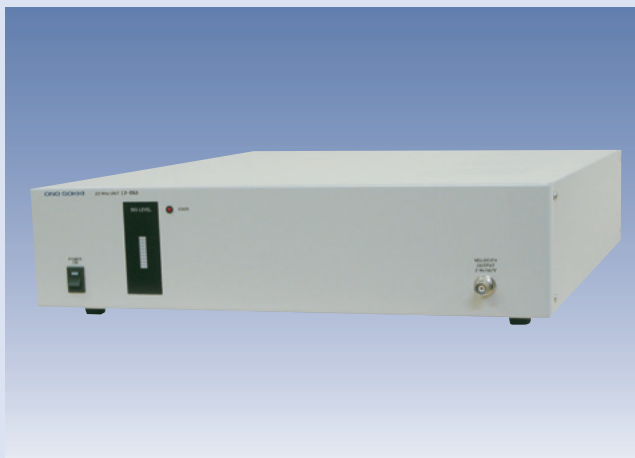

Applications

- High-frequency measurement of crystal oscillators and piezoelectric elements.

Enables measurement up to a frequency of 20 MHz* when connected to the LV-1710/1720 Laser Doppler Vibrometers.

Measurement speed range: 2 mm/s to 2 m/s

Velocity measurement range: 2 (m/s) V

Measurement frequency range: 1 Hz to 20 MHz

Velocity output signal: Analog voltage ±2.5 V

Output impedance: 75 Ω

Power supply: 100 VAC ±10% 1A (120/220/240 VAC on request.)

Operating temperature range: 0 to +40°C

Outer dimensions: 420 (W) x 100 (H) x 500 (D) mm

Weight: Approx. 6.5 kg

* Modification to enable connection is required.

Freely configure your own system from our wide range of options that provide complete support from detection through to analysis.

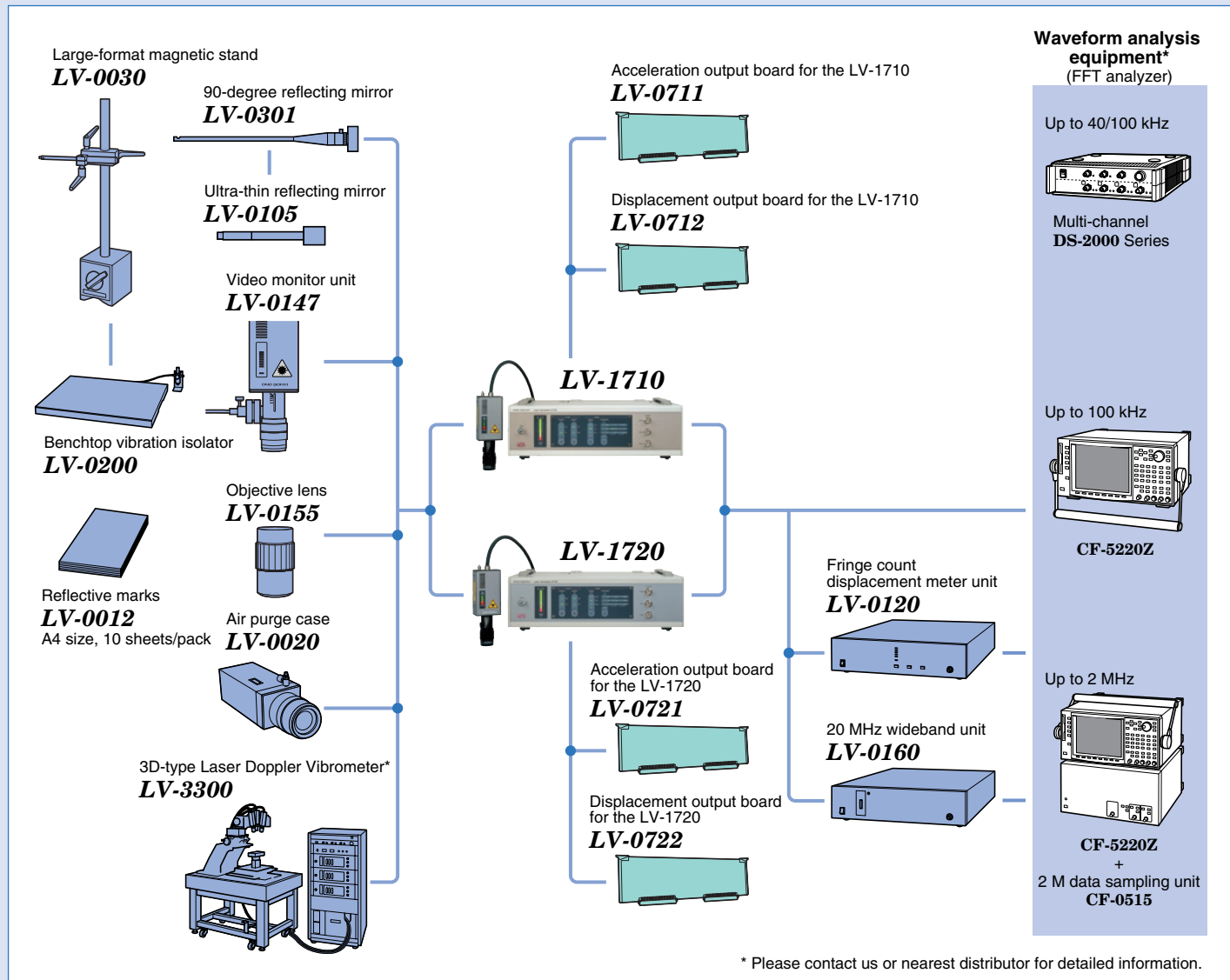

Combining the LV-1700 Series with the LV-0155 objective lens and the LV-0147 video monitor unit enables vibration detection of ultra-small objects.



Laser Doppler Vibrometer A Brief Explanation

If a light wave (wavelength) of a specific frequency is beamed at a moving object, the frequency of the wave reflected from the moving object changes in proportion to the velocity of the object.

This phenomenon is known as the Doppler shift. A proportional relationship between the moving velocity of the object and the Doppler shift is established. This means that if the amount of change caused by the Doppler shift is known, the moving velocity of the object can then be calculated. However, since with a laser Doppler vibrometer, the object under measurement is a vibration phenomenon that has plus and minus velocity vectors, if the laser beam emitted from the laser source is used as is, a problem occurs with the point of judgment with respect to the plus/minus sign. For this reason, the optical heterodyne method utilizing an element called an acousto-optical modulator (AOM) is used.

With this method, the laser beam that has been subjected to a specific frequency shift by the AOM is used as the reference beam, and then made to interfere with the beam reflected from the object in the receiving element. At this time, since the reflected beam is experiencing a Doppler shift from the vibrations of the object under measurement, the beat frequency of the interfered beams becomes an FM-converted wave centered at the shifted frequency from the AOM. This wave is then converted to an electrical signal in the receiving element. After it undergoes FM demodulation, a voltage signal proportional to the vibratory velocity of the object under measurement is obtained, and then output from the converter as a velocity signal with a plus or minus (+/-) sign.

Outline of the Optical Heterodyne Method

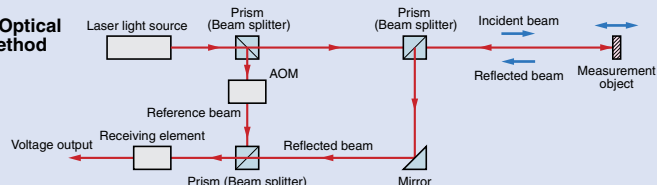

LV-0030 Large size magnetic stand



The magnetic stand is used for positioning the sensor. Using it together with the LV-0015 or LV-0016 fine-positioning stage enables fine adjustment of the detection position.

LV-0015 Fine-positioning XY stage



The XY stage enables precise alignment of the sensor position.
Stage surface: 60 x 60 mm
Movable range: ± 5 mm

LV-0016 Fine-positioning Z stage

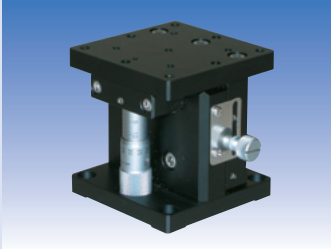

The Z stage enables precise alignment of the sensor up/down position.
Stage surface: 60 x 60 mm
Movable range: 0 to 10 mm

LV-0017 Large size tripod



Used for positioning the sensor in locations where there is no bed plate.

* A conversion adapter is required for direct mounting of the sensor.

LV-0200 Benchtop vibration isolator

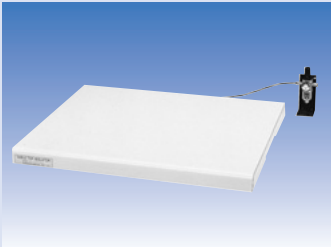

Isolates the sensor from vibrations transmitted through areas such as the floor.

Auto-leveling type.

Size: 500 x 600 x 57 mm

Weight: Approx. 29 kg

Auto-leveling mechanism:

Operated using 0.3 to 0.7 MPa pressurized air or nitrogen gas

LV-0300 Storage trunk



The storage trunk can hold the LV-1710/1720 main unit together with options such as the large-format magnetic stand.

Weight: Approx. 9 kg

LV-0147 Video Monitor Unit



Attaching the video monitor unit to the LV-1710/1720 lens enables easy checking of the laser spot position at a high magnification ratio. Measurement of ultra-small components can be easily performed.

Monitor magnification ratio: Approx. 35 times*

*When a 14" monitor is used

LV-0155 Objective Lens



Attaching the objective lens to the end of the LV-1710/1720 lens enables the laser spot to be focused to approximately 3 μm .

Measurement distance: Approx. 40 mm

* A conversion adapter to enable attachment is provided.

LV-0301 90-degree reflecting mirror



Attaching the mirror to the LV-1710/1720 lens enables the laser beam to be bent 90 degrees and rotated 360 degrees, so that it can be aimed at areas such as small crevices.

LV-0105 Ultra-thin reflecting mirror

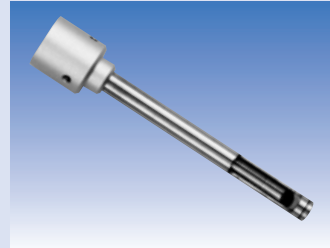

This is a 90-degree reflecting mirror for use in areas that are narrower than the tip of the LV-0301 mirror. It is used to replace the mirror on the tip of the LV-0301. $\phi=4$ mm

LV-0020 Air purge case



Protects the sensor from on-site oil mist and dust.

* A separate air unit is required.

LV-0018 Steel plate

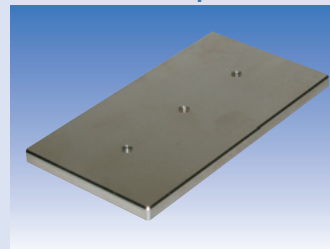

Attaching the steel plate to the tripod enables the magnetic stand to be used on top of the tripod (used horizontally).

LV-1710/1720 Frequency Characteristic Graphs

LV-1710

Frequency characteristic through the HPF at 10 Hz

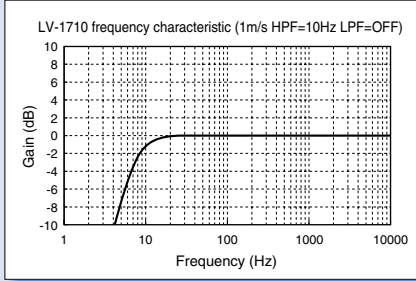

Frequency characteristic through the HPF at 100 Hz

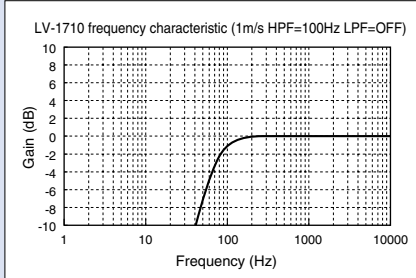

Frequency characteristic through the LPF at 1 MHz

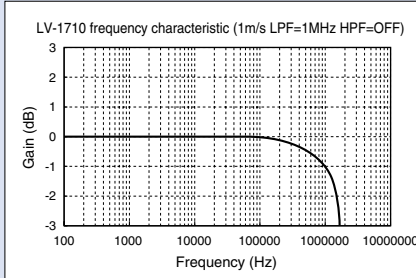

Frequency characteristic through the LPF at 100 kHz

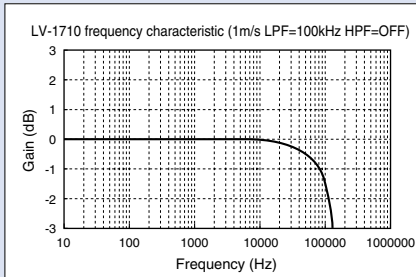

Phase and gain frequency characteristics when the filter is OFF.

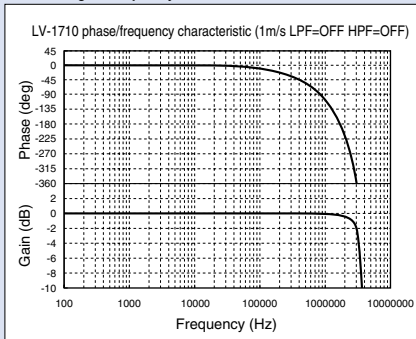

LV-1720

Frequency characteristic through the HPF at 10 Hz

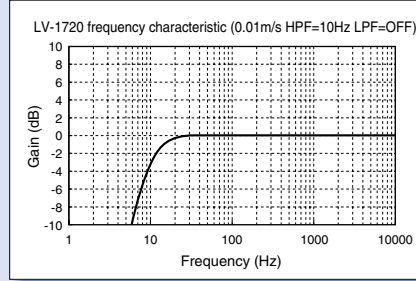

Frequency characteristic through the HPF at 100 Hz

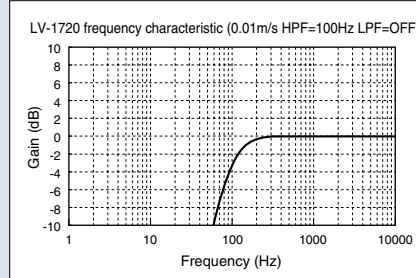

Frequency characteristic through the LPF at 20 kHz

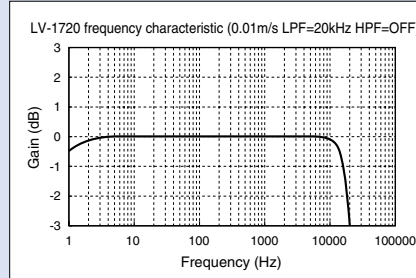

Frequency characteristic through the LPF at 100 kHz

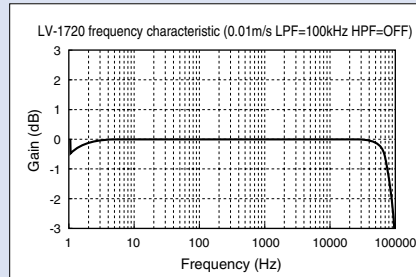

Phase and gain frequency characteristics when the filter is OFF.

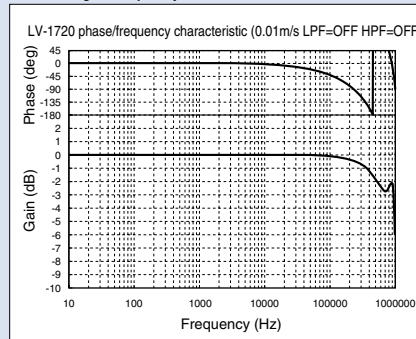

Note: The above frequency characteristics are the standard values for each model.

LV-1710/1720 Specifications

	LV-1710	LV-1720
• Sensor Unit		
Detection demodulation system	Velocity demodulation using optical heterodyne detection	
Light source	He-Ne laser (632.8 nm wavelength)	
Reflected light output	Within 1 mW (conforming to Class 2 JIS C6802 standard)	
Measurement distance	100 mm to 5 m	
Laser spot	20μm or less (at the shortest measurement distance)	
Signal cable length	3 m (can be extended to a maximum of 15 m by modification on request.)	
Display unit	Level display, 10-segment LED bar display Output error display (red LED display)	

• Converter Unit		
Measurement frequency range	1 Hz to 3 MHz	1 Hz to 300 kHz
Velocity range	1 m/s/V (max. 10 m/s)	0.05 m/s/V (max. 0.5 m/s)
	0.1 m/s/V (max. 1 m/s)	0.01 m/s/V (max. 0.1 m/s)
	0.01 m/s/V (max. 0.1 m/s)	0.002 m/s/V (max. 0.02 m/s)
Velocity output	Analogue voltage: ±10 V (DC offset within ±20 mV)	
Minimum velocity resolution	0.3 μm/s	0.1 μm/s (when the range is (when the range is 0.01 m/s/V and the LPF 1 MHz or 1 kHz) OFF)
Output impedance	50 Ω (the lowest input impedance is 100 kΩ or higher)	
Low-pass filter	100 kHz, 1 MHz, OFF	20 kHz, 100 kHz, OFF
High-pass filter	10 Hz, 100 Hz, OFF	10 Hz, 100 Hz, OFF
Monitor output	Analogue voltage: 0 to 10V (output impedance 50 Ω)	
Velocity range display	LED display	
Display unit	Level display, 20-segment LED bar display	
	Laser emission (green LED)	
	Velocity overrange (red LED)	
	Sensor error display (red LED)	
Storage	The sensor unit fits into the conversion unit, and the cable is wound up on the rear panel.	

• External Remote		
Safety lock	Intercepts the laser beam path (laser emission when the beam path is short.) Non-voltage 1a contact input	
Mechanical shutter	Intercepts the laser beam path when the main unit's key switch or the safety lock is activated.	
Interface	RS-232C	

• General Specifications		
Operating power supply	100 to 240 VAC, 50/60 Hz	
Operating temperature range	0 to 40°C	
Operating humidity range	30 to +80% RH (non-condensing)	
Storage temperature range	-10 to +50°C	
Sensor weight	Approx. 650 g (excluding the cable)	
Main unit weight	Approx. 12 kg (including the sensor)	
Power consumption	65 VA or less (at 100 VAC, 50 Hz)	

• Certifications

The LV-1710/1720 models have been designed and tested in accordance with the following standards.

[JIS C6082 (Laser Product Emission Safety Standards)] [IEC60825-1:2001] [FDA(CDRH)] [CE Marking (Low Voltage Directive: EN61010-1) (EMC directive: EN61326)] [FCC(Part 15B)] [CANADA EMI Standard(ICES-003)]



• Outer Dimensions (common to both LV-1710/1720)

Unit: mm

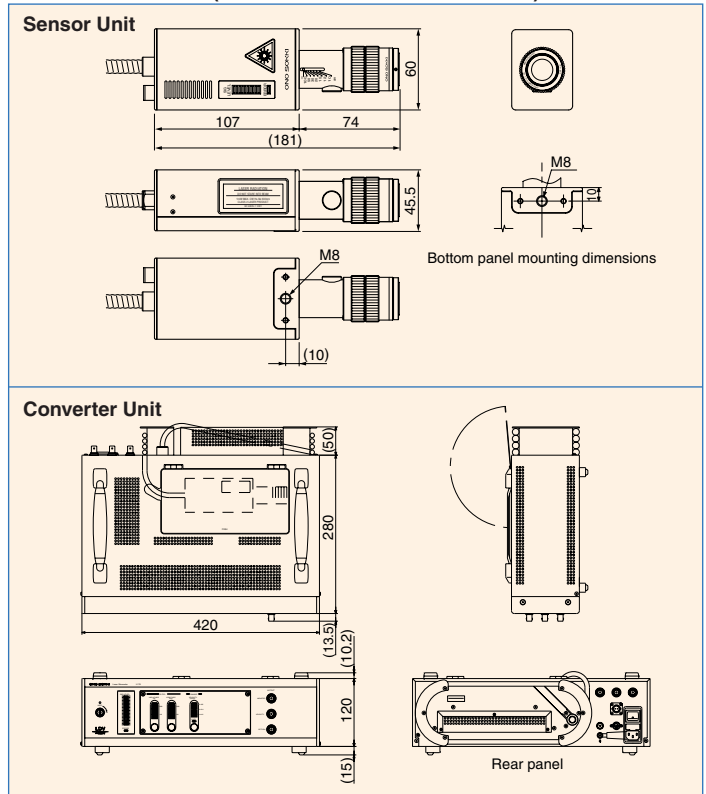

• LV-1710/1720 Measurement Ranges

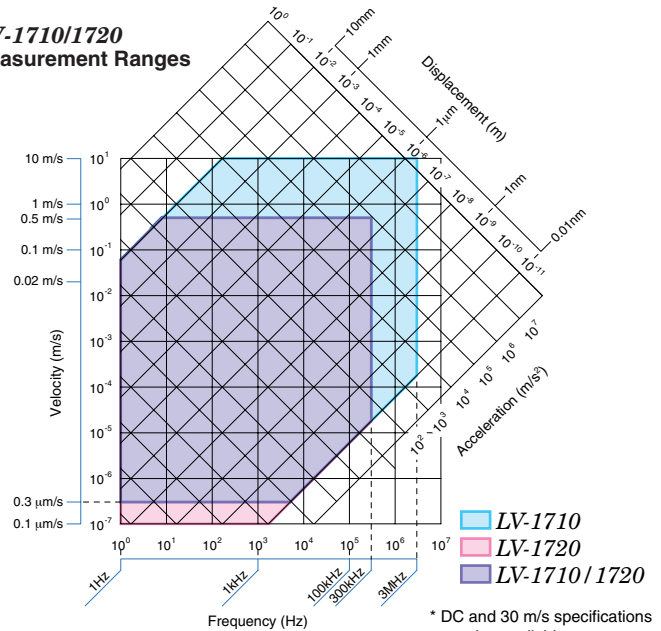

* DC and 30 m/s specifications are also available. Please contact us for further details.

* Outer appearance and specifications are subject to change without prior notice.

URL: <http://www.onosokki.co.jp/English/english.htm>

ONOSOKKI

U.S.A. & CANADA

Ono Sokki Technology Inc.
2171 Executive Drive, Suite 400
Addison, IL. 60101 U.S.A.
Phone: 630-627-9700
Fax: 630-627-0004
URL: <http://www.onosokki.net>
E-mail: info@onosokki.net

P.R.CHINA

Ono Sokki Beijing Office
Beijing Jing Guang Center 3510
Hu Jia Lou, Chao Yang Qu
Beijing P.R.C. 100020
Phone: 010-6597-3113
Fax: 010-6597-3114
E-mail: onosokki@public.bta.net.cn

WORLDWIDE

Ono Sokki Co., Ltd.
1-16-1 Hakusan, Midori-ku,
Yokohama 226-8507, Japan
Phone: 045-935-3976
Fax: 045-930-1906
E-mail: overseas@onosokki.co.jp